

COSCO®

SIMPLE

SMART

FUN

COSCO®

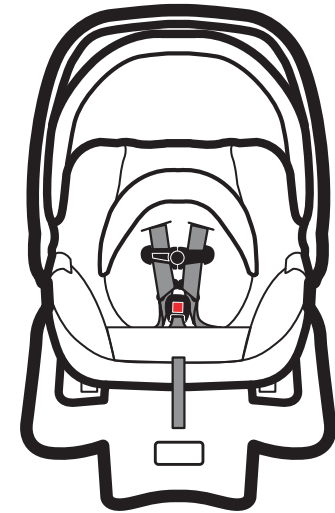

## LIGHT 'N COMFY DX, LX INFANT CAR SEAT

4-22 lb and 29 in. or less  
(1.8-10 kg and 74 cm or less)

**KEEP INSTRUCTIONS FOR FUTURE USE.**  
Read all instructions before using this child restraint.

**⚠ WARNING:**

Failure to follow the warnings on the labels and in the instruction manual can result in serious injury or death to your child.

[www.coscokids.com](http://www.coscokids.com).

©2016 Dorel Juvenile.  
4358-7106

Your child's height, weight, and age determine how your child restraint should be placed in the vehicle.

Children up to 1 year of age must ride rear facing.

The American Academy of Pediatrics recommends that children should remain rear facing until they are at least 2 years old.







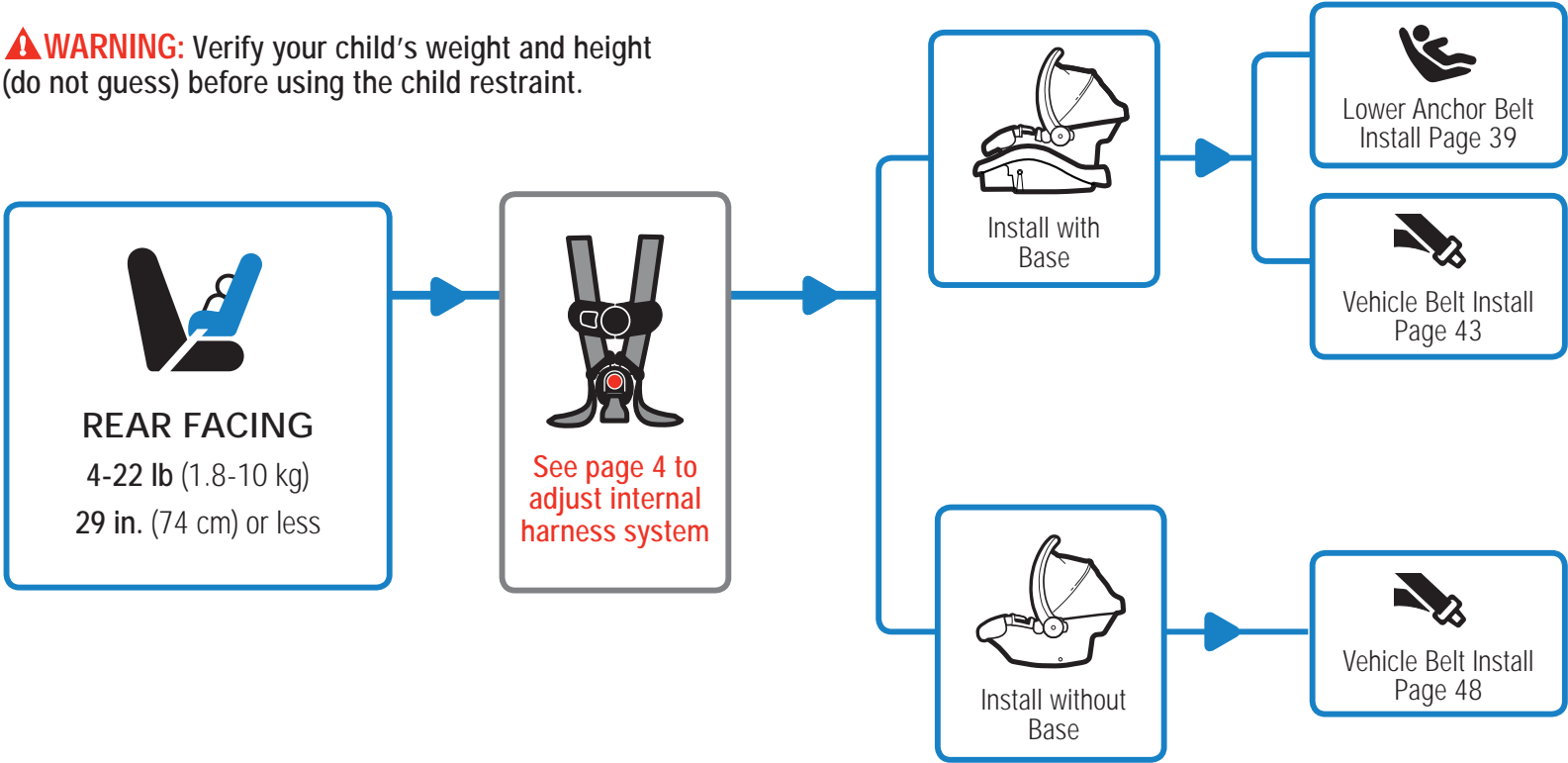



Please talk to your doctor about the best option for your child.

This child restraint must always be used rear facing.

**⚠️ WARNING:** Verify your child's weight and height (do not guess) before using the child restraint.



## Table of Contents

	<b>Getting Started</b> .....	<b>1</b>
	Parts of the Child Restraint.....	1
	Prepare Child Restraint to Fit Your Child .....	4
	How Does Your Child Fit? .....	5
	Changing Position of Buckle .....	6
	Changing Position of Shoulder Harness Strap .....	8
	Buckle Placement for Smaller Infants .....	10
	Securing Child in Child Restraint.....	11
	<b>General Use</b> .....	<b>16</b>
	Removing and Installing Child Restraint to Base .....	16
	Adjusting the Base (on select models) .....	17
	Carrier Use .....	18
	Removing Harness System .....	19
	Removing Seat Pad for Cleaning.....	22
	Installing Harness System .....	24
	Canopy Use and Removal.....	27
	Accessories on Select Models .....	29
	<b>Safety Information</b> .....	<b>30</b>
	Child Restraint Use .....	30
	Installation in Vehicle .....	30
	Vehicle Seating Position.....	31
	<b>Vehicle Information</b> .....	<b>32</b>
	Choosing Lower Anchor Belt or Vehicle Belts .....	32
	Knowing Your Vehicle Belts.....	34
	Aircraft Information .....	37
	<b>Rear Facing with Base</b> .....	<b>38</b>
	 Lower Anchor Belt Installation with Base .....	39
	 Vehicle Belt Installation with Base .....	43
	<b>Rear Facing without Base</b> .....	<b>47</b>
	 Vehicle Belt Installation without Base .....	48
	<b>Important Information</b> .....	<b>51</b>
	Using a Locking Clip .....	51
	Dorel Juvenile Group Information.....	53
	Registration and Safety Notices .....	54
	Troubleshooting.....	55
	Replacement Parts Order Form.....	56
	Warranty.....	58

## Parts of the Child Restraint

Front View

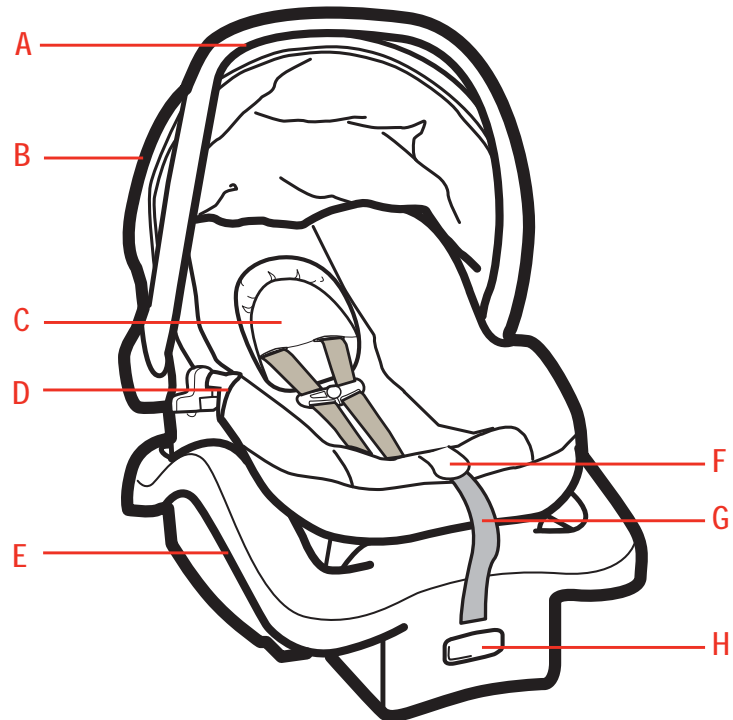

- A. Carry Handle
- B. Canopy
- C. Infant Insert  
(see page 29)
- D. Vehicle Belt Path Guide  
(when used without the  
base)
- E. Adjustable Base
- F. Harness Release Lever  
(through opening in pad)
- G. Harness Adjustment  
Strap
- H. Recline Foot Release  
Button

Back View

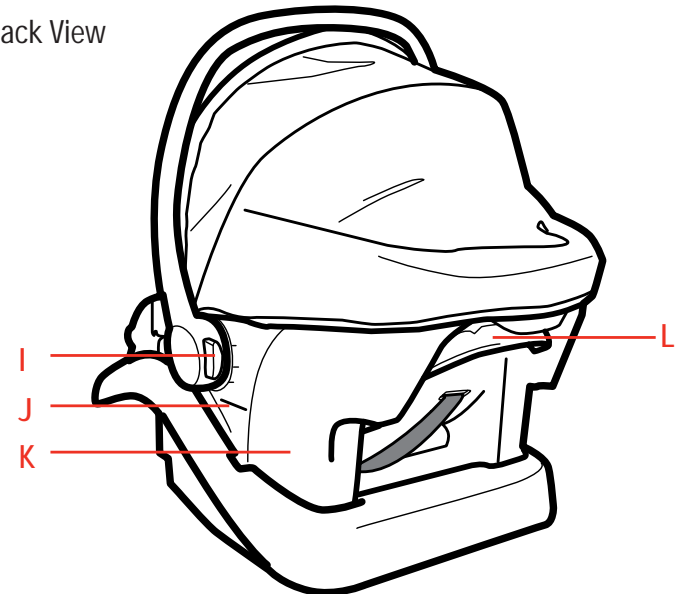

- I. Carry Handle  
Adjustment Button
- J. Rear-Facing Level Line
- K. Shell (child restraint)
- L. Base Release Handle

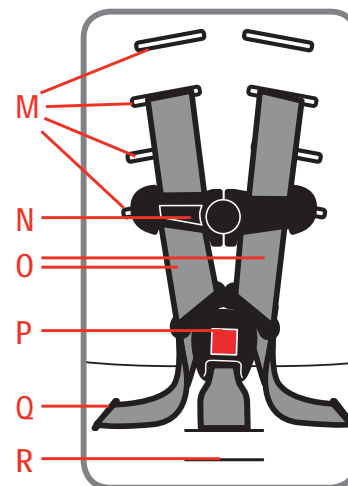

Harness System Detail

- M. Shoulder Harness  
Slots
- N. Chest Clip
- O. Harness Strap
- P. Buckle
- Q. Hip Harness Slots
- R. Buckle Slots

## Prepare Child Restraint to Fit Your Child

Bottom of Child Restraint

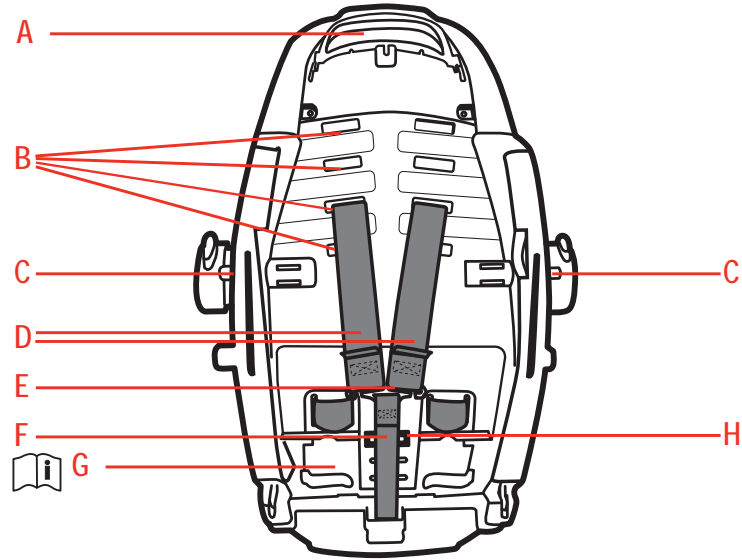

- A. Base Release Handle
- B. Shoulder Harness Slots
- C. Stroller Attachment Pins
- D. Harness Strap
- E. Splitter Plate
- F. Harness Adjustment Strap
- G. Instruction Manual Storage
- H. Buckle's Metal Retainer

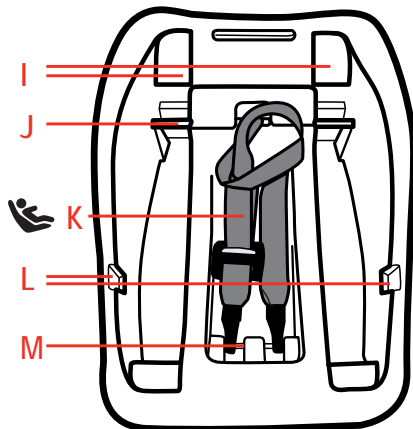

Top of Base

- I. Base Belt Path
- J. Lock Bars
- K. Lower Anchor Belt
- L. Base Alignment Slots
- M. Lower Anchor Belt Storage

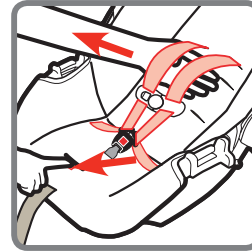

### 1. Fully Loosen Harness Straps

Push down on harness release lever (through opening on front of seat pad) while pulling out on harness straps as shown.

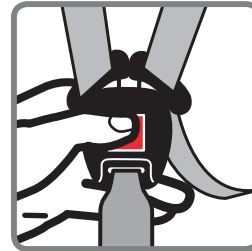

### 2. Unbuckle Harness

Press in on the red button.  
Pull buckle tongues out.

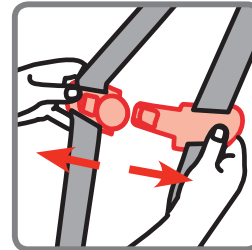

### 3. Release Chest Clip

Press on chest clip release button and pull apart.

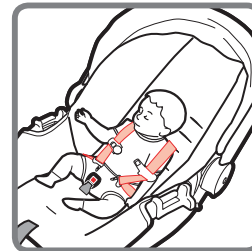

### 4. Place Child in Child Restraint to Determine Proper Harness Fit

The child's bottom and back should be flat against the child restraint.

See page 5 for fit guidelines.



Use the guidelines below to determine if the buckle and harness strap are in the right place for your child.

### REAR FACING

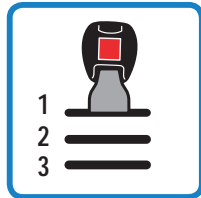

#### Buckle Position

Start in the 1st slot and adjust outward as your child grows.

Buckle should be used in the slot closest to your child. It should not be underneath or behind your child.



#### Harness Strap Position

Always choose the shoulder harness slots that are closest to your child's shoulder height.

Harness strap **MUST** be at or slightly **below** shoulders.

If the lowest shoulder harness slots are above the child's shoulders, **do not** use this child restraint.

To change buckle position, see pages 6-7.

To change harness strap position, see pages 8-9.

To adjust buckle placement for smaller infants, see page 10.

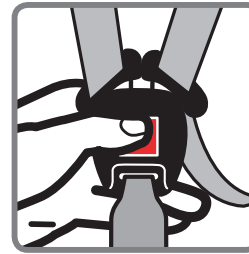

#### 1. Unbuckle Harness

Press in on the red button.  
Pull buckle tongues out.

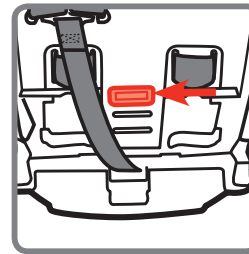

#### 2. Turn Seat Over

Locate buckle's metal retainer on bottom of shell.

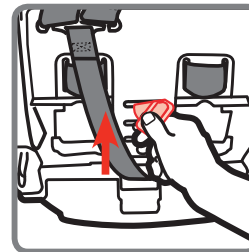

#### 3. Rotate Metal Retainer and Push It Up Through Shell and Pad

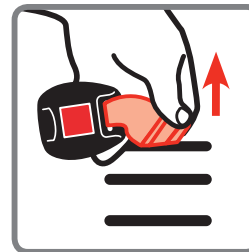

#### 4. From Top of Seat, Pull Buckle Out of Shell and Pad



5. Insert Buckle's Metal Retainer into Slot Closest to Child

Buckle **MUST** face out.



6. Pull Metal Retainer Completely Through Pad and Shell



7. Check Buckle

Pull up on buckle to make sure it is secured.

The buckle **MUST** not pull out.

**⚠ WARNING:** Failure to place buckle's metal retainer completely through pad and shell can result in serious injury or death.

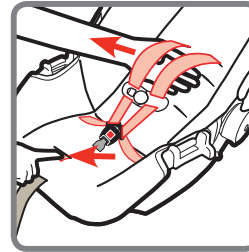

1. Fully Loosen Harness Straps

Push down on harness release lever (through opening on front of seat pad) while pulling out on harness straps as shown.

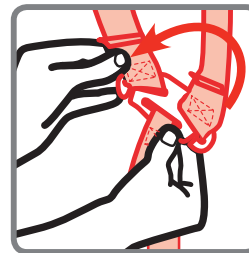

2. From Back of Seat, Remove Harness Strap Loops From Splitter Plate

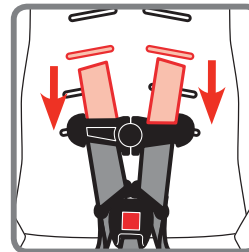

3. Pull Harness Strap Out of Shoulder Harness Slots

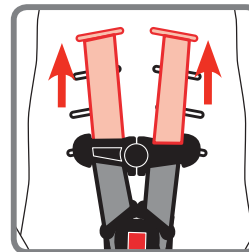

4. Rethread Harness Strap Into Correct Shoulder Harness Slots For Your Child



**5. Attach Harness Strap Loops to Splitter Plate**

Sewn ends of the harness strap loops **MUST** face towards you.

**DO NOT** twist harness strap or harness adjustment strap.

Make sure the harness strap loops are fitted **COMPLETELY ON** both sides of the splitter plate.

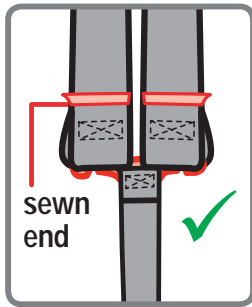

**⚠ WARNINGS:** Make sure that the harness height is correct for your child's size.



Do not use this child restraint unless the top of your child's head is at least 1 in. (2.5 cm) below the top of the child restraint.

Failure to follow these steps can result in serious injury or death.

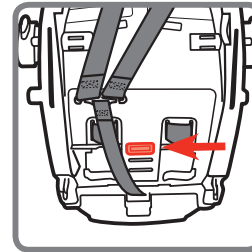

**1. With Buckle in the 1st Slot As Shown, Turn the Seat Over**

If you need to move the buckle to the 1st slot, see pages 6-7.

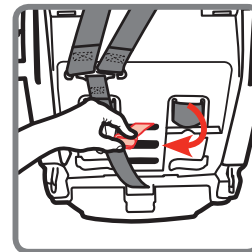

**2. From Bottom of Seat, Pull Metal Retainer Towards You and Push It Up into 2nd Slot As Shown**

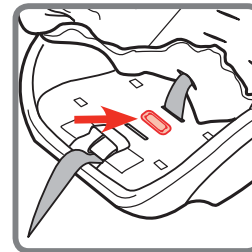

**3. From Top of Seat, Lift Pad Up and Lay the Metal Retainer Flat Against the Shell As Shown**

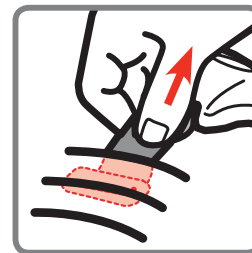

**4. Replace Pad and Check Buckle**

Pull up on buckle to make sure it is secured.

The buckle **MUST** not pull out.





## Securing Child in Child Restraint

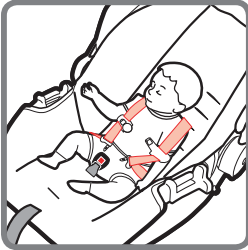

### 1. Place Child in Child Restraint

The child's bottom and back should be flat against the child restraint.

Position harness strap over child's shoulders and upper thighs.

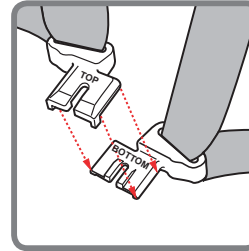

### 2A. Put Buckle Tongues Together

Fit top buckle tongue over bottom buckle tongue.

Depending on your model, you may have a puzzle buckle. If your buckle is different from step 2, follow steps 2A and 2B.

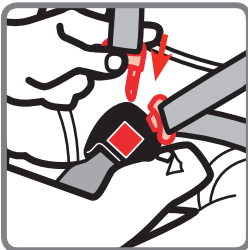

### 2. Buckle Harness

Push buckle tongues into buckle until you hear them "click."

Pull up on harness strap to make sure buckle is locked.

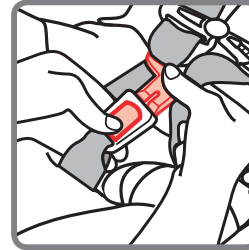

### 2B. Buckle Harness

While holding the buckle tongues together, push buckle tongues into the buckle until you hear a "click."

Pull on the harness straps just above the buckle to make sure the buckle tongues are locked into place.

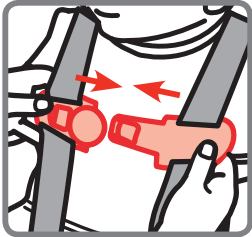

### 3. Close Chest Clip

Insert right half of chest clip into left half and snap together.

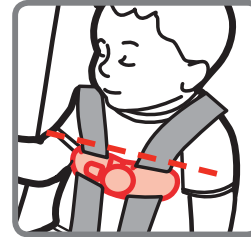

### 5. Position Chest Clip

The chest clip must be placed at mid-chest (even with armpits) and away from the child's neck.

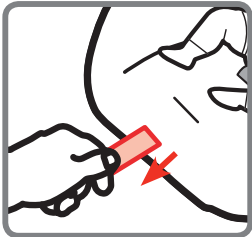

### 4. Tighten Harness

Pull on harness adjustment strap to tighten harness snugly.

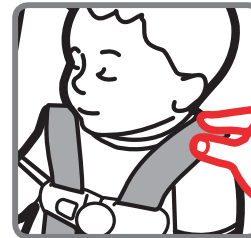

### 6. Check Harness Tightness

Try to pinch the harness at the shoulders vertically between index finger and thumb as shown.

**If your fingers slip off**, the harness is tight enough.

**If you can pinch the harness strap**, tighten more. The harness straps should be snug throughout their length.

A snug strap should not allow any slack. It lies in a relatively straight line without sagging. It does not press on the child's flesh or push the child's body into an unnatural position.



**⚠ WARNINGS:** Failure to fasten and tighten the harness system correctly may allow the child to be ejected from the child restraint in a crash or sudden stop causing serious injury or death.

Do not mistake comfort for safety. Harness system must be snugly adjusted.



DO NOT put snowsuits or bulky garments on your infant when placing them in the child restraint.

Bulky clothing can prevent the harness straps from being tightened properly.

To Remove Child From Child Restraint:

1. Loosen Harness Strap
2. Unbuckle Harness
3. Release Chest Clip
4. Remove Child

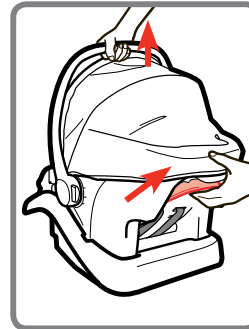

To Remove Child Restraint from Base

From the back of the child restraint, slide the base release handle up and lift the child restraint out of the base.

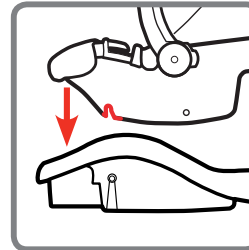

To Attach Child Restraint to Base

Align the slots on the side of child restraint with the lock bars in the base.

Push down firmly on the carry handle and front of the child restraint to lock it to the base. You will hear a "click" when it is locked.

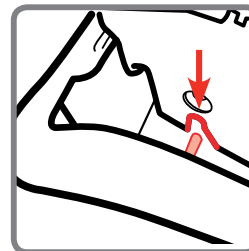

Pull up on front two corners of child restraint by infant's feet to make sure it is locked to the base.

**⚠ WARNINGS:** Failure to securely attach child restraint to base can result in serious injury or death.



## Adjusting the Base (on select models)

Depending on your model, the base may have a recline foot. Follow the directions below if your model has the recline foot.

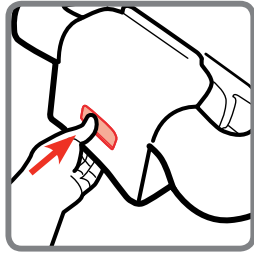

### To Lower the Base Foot

Push in on the foot release button and pull the foot all the way down.

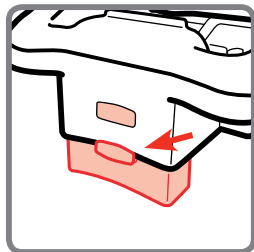
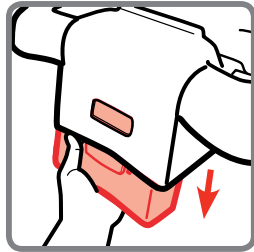

Lock the foot on the release button as shown.

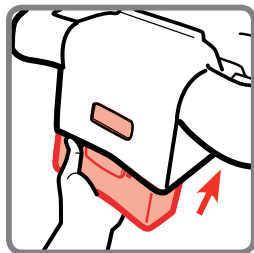

### To Store Base Foot

Pull the foot down and press in on the release button.

Push the foot up into the base to the locked position.

## Carrier Use

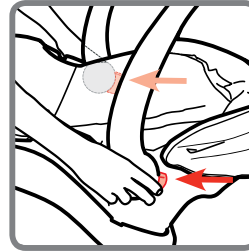

### To Adjust Carry Handle

Squeeze both adjustment buttons on each side of the carry handle.

Rotate up or down to desired location. Release buttons.

Make sure both carry handle adjuster buttons are in the locked position.



Carry handle **MUST** be upright AND locked when carrying and when installed in the vehicle.

**⚠ WARNING:** DO NOT use in the seating area or across the top of shopping carts.

### **⚠ WARNING:**

Read ALL instructions before using child restraint as a carrier.

**NEVER** use carrier unless child is properly secured.

Use only as a carrier by children weighing 4-22 pounds (1.8-10 kg) and 29 inches (74 cm) or less.

**NEVER** leave child unattended. Always keep child within arm's reach.

**Suffocation Hazard:** Infant carrier can roll over on soft surfaces and suffocate child. **NEVER** place carrier on beds, sofas or other soft surfaces.

**Strangulation Hazard:** Children have **STRANGLD** in loose or partially buckled harness straps. Fully restrain the child even when carrier is used outside the vehicle.

**Fall Hazard:** Child's movement can slide carrier. **NEVER** place carrier near edges of counter tops, tables or other elevated surfaces.

Do not use the carrier if it is damaged or broken, or if any parts are missing.



## Removing Harness System

Only remove the harness system to clean the seat pad.  
To remove accessories, see page 29.

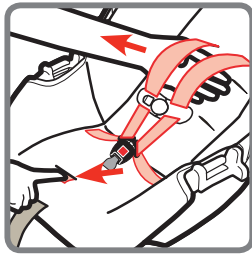

### 1. Fully Loosen Harness Strap

Push down on harness release lever (through opening on front of seat pad) while pulling out on harness straps as shown.

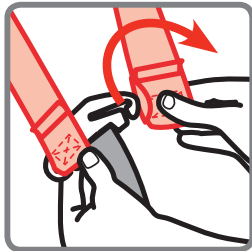

### 2. From Back of Seat, Remove Harness Strap Loops From Splitter Plate

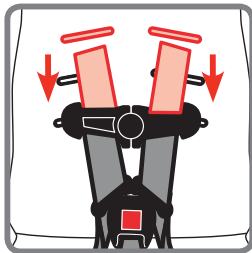

### 3. Pull Harness Strap Out of Shoulder Harness Slots

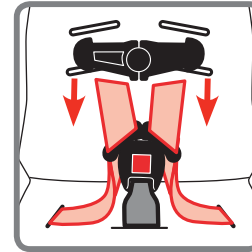

### 4. Unthread Chest Clip

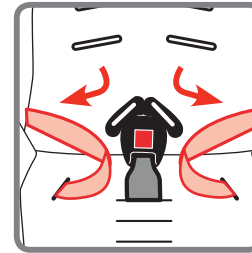

### 5. Unthread Buckle

Do not unbuckle the buckle.

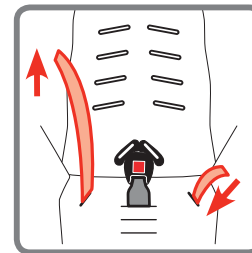

### 6. Pull Harness Strap Out of Seat

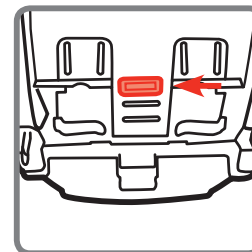

### 7. Turn Seat Over

Locate buckle's metal retainer on bottom of shell.

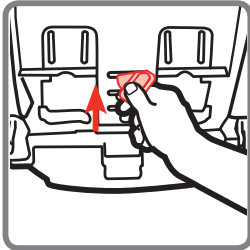

8. Rotate Metal Retainer and Push It Up Through Shell and Pad



9. From Front of Seat, Pull Buckle Out of Shell and Pad

You must remove the harness system in order to remove the pad. See pages 19-21.

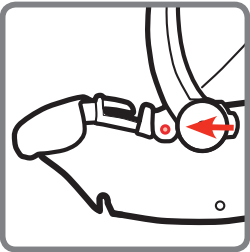

1. Release the Pad Tabs

Pull down on the pad and pull the tab out of the shell.  
Repeat for other side.

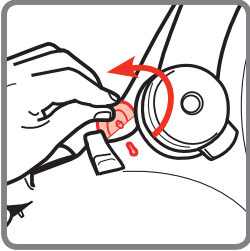

2. Remove the Elastic Straps

Pull the elastic strap off of the belt path guide as shown on both sides.  
Repeat for other side.

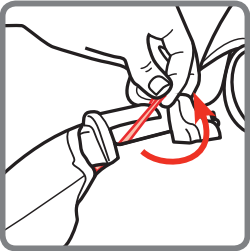
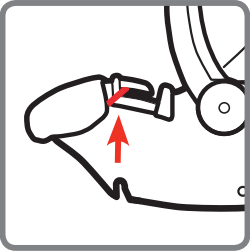

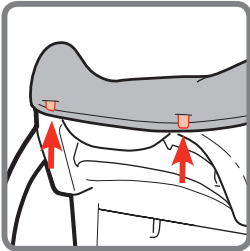

3. Pull Pad off Tabs from Top of Shell

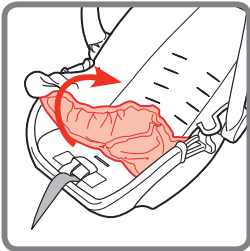

4. Remove Pad from the Bottom of Shell  
Remove pad from shell.

**⚠ WARNINGS:** Do not use child restraint without the seat pad. Failure to do this can result in serious injury or death.

**Cleaning Pad and Accessories**

Machine wash separately with cold water on a gentle cycle. Do not use bleach. Tumble dry separately for 10-12 minutes on low heat. Remove immediately.

To clean canopy, hand wash using warm sudsy water. Line dry.

**Cleaning Harness Strap**

Spot clean using warm sudsy water and damp cloth.

**Replacing Pad**

Starting from top of child restraint, slip pad on shell. Push pad tabs at top of shell through slots in pad. Pull harness adjustment strap through slot in pad. Wrap pad around bottom of shell.

Attach the tabs on the sides to shell. Attach elastic straps to the belt path guide.

Install harness system. See pages 24-26.



1. Insert Buckle's Metal Retainer into Slot Closest to Child  
Buckle **MUST** face out.

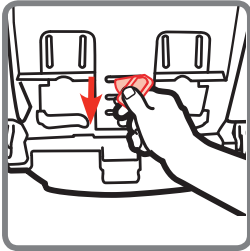

2. Pull Metal Retainer Completely Through Pad and Shell



3. Check Buckle  
Pull up on buckle to make sure it is secured.  
The buckle **MUST** not pull out.

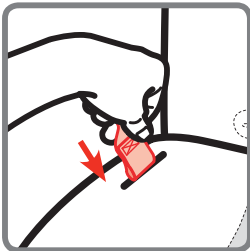

4. Rethread Harness Strap  
With sewn end of harness strap loop facing the buckle, thread harness strap down through hip harness slot.

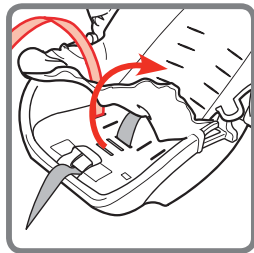

5. Pull Up Front of Seat Pad

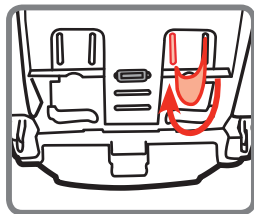

6. Weave Harness Strap In and Out of Shell As Shown

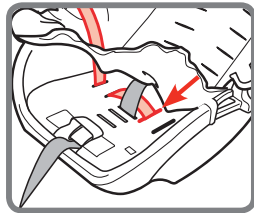

7. Make Harness Strap Even  
Sewn ends of harness strap loops **MUST** face each other.

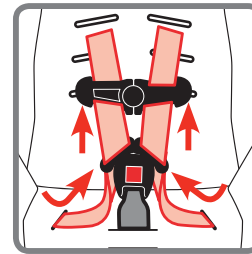
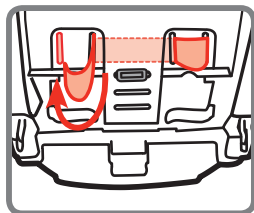

8. Thread Buckle and Chest Clip

Harness strap ends go through the back of buckle tongues and through the chest clip front to back as shown.

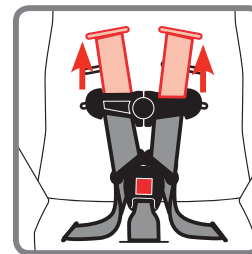

9. Thread Harness Strap into Correct Shoulder Harness Slots For Your Child

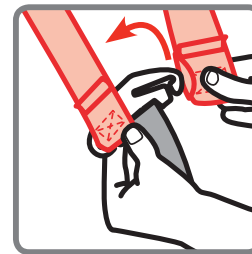

10. Attach Harness Strap Loops to Splitter Plate

Sewn ends of the harness strap loops **MUST** face towards you.

**DO NOT** twist harness strap or harness adjustment strap.

Make sure the harness strap loops are fitted **COMPLETELY ON** both sides of the splitter plate.

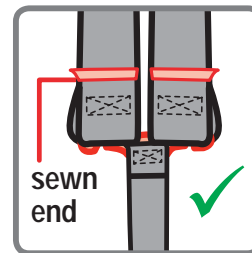

**⚠ WARNINGS:** Harness system must be installed correctly. Failure to follow these steps can result in serious injury or death.





## Canopy Use and Removal

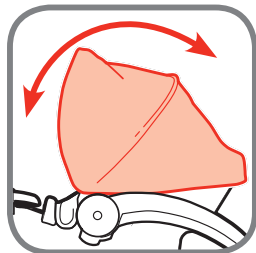
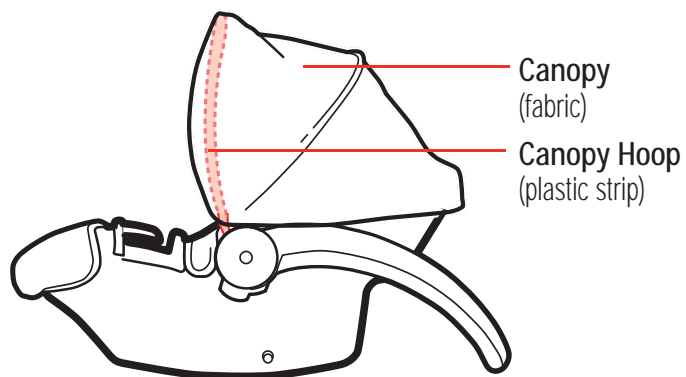

### To Adjust Canopy

Grasp the front or sides of the canopy hoop and move it front to back to desired location.

### To Clean Canopy

Hand wash using warm sudsy water. Line dry.

### To Remove Canopy

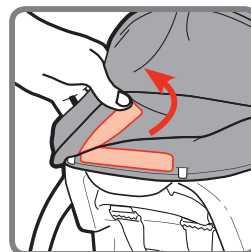

1. Undo Fastening Strip on the Back of the Shell

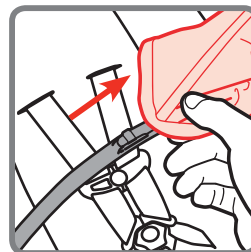

2. Expose Canopy Hoop Connection in the Middle of the Hoop by Sliding Canopy Fabric to One Side of the Shell

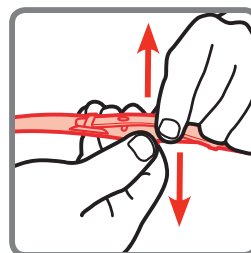

3. Undo Canopy Hoop

Pull top of the canopy hoop up and the bottom down where they connect.

Then pull the hoop apart and pull the canopy fabric off of the hoop.

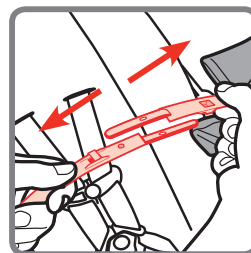

Reverse to put back together.



## Accessories on Select Models

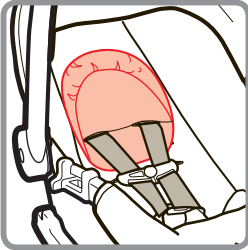

### Basic Insert

When using the infant insert, make sure it does not cover your infant's face in any way. Remove the insert for older babies.

**To remove infant insert**, remove harness straps from splitter plate.

Pull harness through the top slots and remove the insert.

Attach harness strap loops to splitter plate. See pages 8-9.

Reverse to install the infant insert.

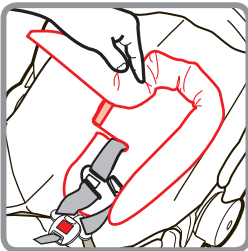

### Deluxe Insert

When using the infant insert, make sure it does not cover your infant's face in any way. Remove the insert for older babies.

**To remove infant insert**, undo the fastening strips and pull the infant insert out from behind the harness straps.

**To install infant insert**, undo the fastening strips and fit the head/hip roll behind the harness straps. Refasten the fastening strips.

## Child Restraint Use



Never take your child out of the child restraint while the vehicle is moving.

Never leave child unattended.

Placing your child in a hot child restraint may result in burns.

Do not use a child restraint with damaged or missing parts.

Do not use cut, frayed or damaged harnesses.

Do not substitute parts or try to modify the child restraint in any way.

Do not lubricate buckles and fasteners.

Do not use any child restraint accessory except those approved by Dorel Juvenile Group.

Never allow any child to play with this child restraint; it is not a toy.

Do not remove or cover up any of the warning labels or other labels on the child restraint.

Read all instructions for additional warnings.

On the side of the child restraint there is a date of manufacture label. Do not use this child restraint more than 8 years after the date of manufacture.

### Installation in Vehicle

Check the vehicle belt or lower anchor belt before each use. Use only if the belt is tightened properly and locked securely in place.

This child restraint should be securely belted in the vehicle even when not in use. In a crash or sudden stop, an unsecured child restraint could injure occupants.

Do not use a child restraint that has been in a crash. You must get a new child restraint.



## Vehicle Seating Position



Never place a child rear facing in a seating position with an active frontal air bag.

Check the vehicle owner's manual for more information about air bag/child restraint use.



Use the child restraint only on vehicle seats that face forward.

Do not use on seats that face the sides or rear of the vehicle.



Use the center seating position if possible.

For vehicles without a back seat, refer to your vehicle owner's manual.

If you are not sure where to place the child restraint in your vehicle, consult your vehicle owner's manual, contact Dorel Juvenile Group Consumer Care Department, or visit your local Child Passenger Inspection Station. Go to <http://www.safercar.gov/cpsApp/cps/index.htm> to find your closest station.



Children are safer when properly restrained in rear seating positions than in the front seating positions.

According to National Highway Traffic Safety Administration information, children in rear seating positions are statistically safer, whether you have air bags, advanced air bags, or no air bags at all.

**To avoid your child being seriously burned, take the following precautions:**

1. Park in the shade or where sun does not directly hit the child restraint.
2. Cover the child restraint with a sheet or blanket when not in use.
3. Check for hot seat and buckles before placing child in child restraint.

To help protect your vehicle seat's upholstery from damage, use a single layer towel underneath and behind child restraint.

## Choosing Lower Anchor Belt or Vehicle Belts

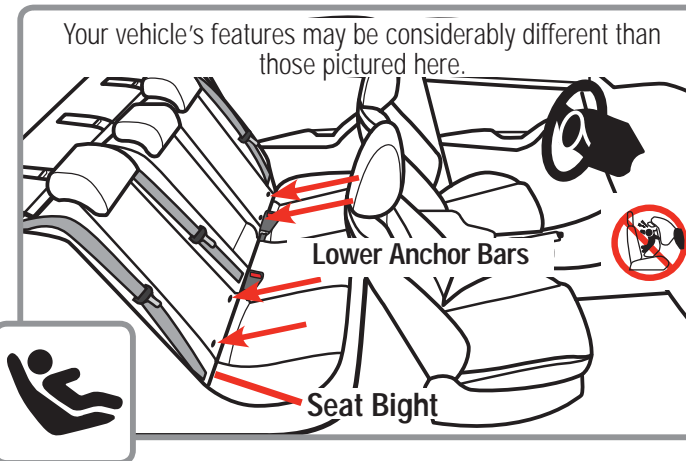

### The LATCH System

The lower anchors of LATCH (Lower Anchors and Tethers for CHildren) is a universal system for installing child restraints without using vehicle seat belts.

The lower anchor system can ONLY be used in vehicles that have the lower anchor bars installed and designated LATCH seating positions. Most vehicles manufactured after September 2002 are equipped with lower anchor bars.

Check your vehicle owner's manual to see which seating positions may be equipped with the LATCH system.

**When installing this child restraint with vehicle belts, the lower anchor hooks and belt MUST be properly stored.**

**To store the lower anchor belt on this child restraint:**

Attach hooks to the storage attachments in base.

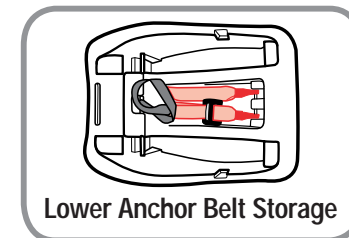
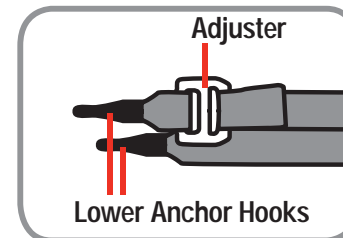

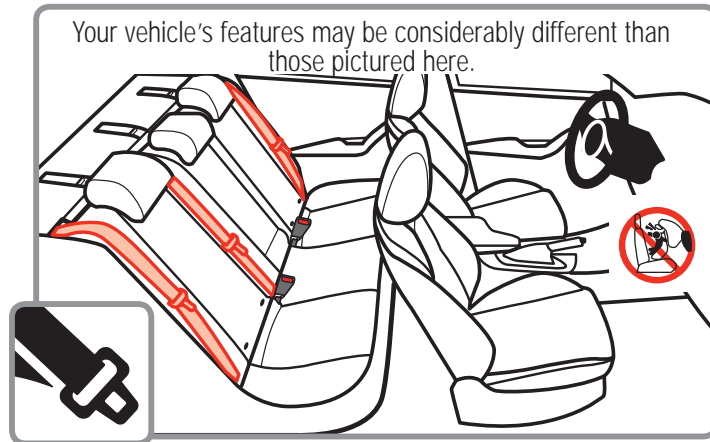

### Vehicle Belts

If lower anchors are not an option, you must use the vehicle seat belt system to install the child restraint.

There are some vehicle belts that will not work with a child restraint or will require special attention.

Check your vehicle owner's manual for specific instructions.

**⚠️ WARNINGS:** When used correctly the lower anchor belt or vehicle belts are equally safe. Do not use both the lower anchor belt and vehicle belt at the same time.

Not all vehicle belts and seating positions will work with child restraints. Please follow the following steps to understand how to lock a child restraint with a vehicle belt.

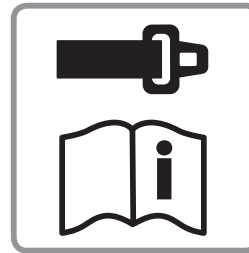

#### 1. You MUST Review Your Vehicle Owner's Manual

Your vehicle owner's manual will let you know what vehicle belts and seating positions child restraints can be installed in.



#### 2. Determine How the Child Restraint Will Be Locked Into Place

The vehicle belt MUST NOT loosen after tightening.

This means there needs to be a way to lock the vehicle belt.

The ways this can be done are:

- By using the seat belt's retractor; or
- By using the seat belt's latch plate.

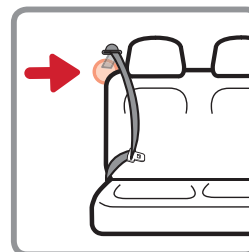

#### 3. Check the Retractor

Retractors pull seat belts into stored positions and lock the belt to hold passengers in place.

A retractor is most likely how you will be locking a child restraint into place.

See the next page for some common types of vehicle belt retractors that will work with this child restraint.

## Types of Retractors

**Switchable Retractor**  
(most vehicles have this type)



This retractor can be switched to a locking mode.

You **MUST** have the retractor in the locking mode to use the seat belt with this child restraint.

**Switching to locking mode:** Slowly pull the shoulder belt all the way out, then let it go back in an inch or two.

As it goes back, in you will most likely hear a ratcheting sound.

Gently pull the belt to see if it has locked. You will not be able to pull any more belt out if the lock has engaged.

**Automatic Locking Retractor**



This retractor always locks.

It will automatically lock after slowly pulling the seat belt out at least halfway and letting the belt go back into the retractor an inch or two.

**Emergency Locking Retractor**

See Step 4, "Check the Latch Plates," on next page.

If the retractor does not lock, it is most likely an Emergency Locking Retractor. These retractors only lock during a sudden stop or collision.

You will need to determine if your seat belt's latch plate can lock the belt. See Step 4, "Check the Latch Plates," on next page.

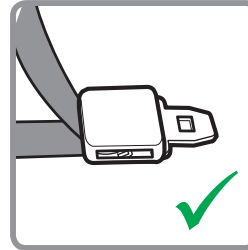
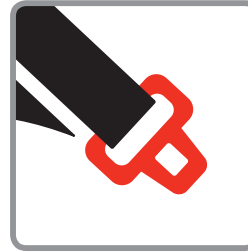

Locking Latch Plate

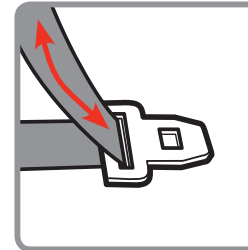

Emergency Locking Retractor with a Sliding Latch Plate

### 4. Check the Latch Plates

Latch plates are the part of the seat belt that goes into the buckle.

Grasp the tongue of the latch plate (the part that goes inside the buckle) and pull straight out, in line with the lap belt.

If the latch plate does not slide up and down the vehicle belt, it is a **locking latch plate**.

If the latch plate slides up and down the vehicle belt, it is a **sliding latch plate**.

Sliding latch plates easily slip between the lap and shoulder portions of the belt.

If you have an Emergency Locking Retractor with a Sliding Latch Plate, you **MUST** use a locking clip to install the child restraint. See pages 51-52.

### Never Use With This Child Restraint

Emergency Locking Retractor Lap Only Belt	✗
Inflatable Seat Belts	✗



## Aircraft Information

This restraint is certified for aircraft use.

Install the child restraint in a window seat to avoid blocking the aisle. If the aircraft lap belt is too short, ask the flight attendant for a belt extender.

Use only on forward facing aircraft seats.

Contact the airline for their specific policies.

Some airlines may ask to see a label stating that this child restraint is certified for aircraft use.



There is an airplane certification label located on the side of this child restraint as shown.



### Rear Facing Aircraft Installation

For rear facing without base installation follow pages 48-50.

## Rear Facing with Base

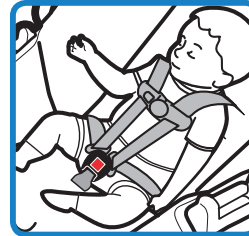

4-22 lb (1.8-10 kg)

29 in. (74 cm) or less

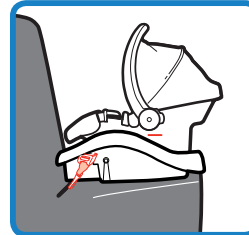

Lower Anchor Belt

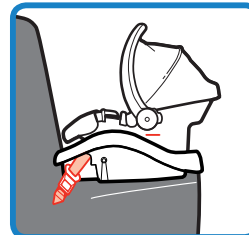

Lap Belt

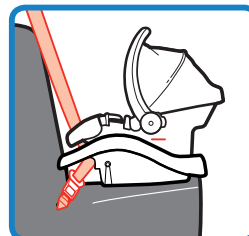

Lap/Shoulder Belt



**⚠ WARNINGS:** Never place a child rear facing in a seating position with an active frontal airbag. This can result in serious injury or death.

This child restraint must always face the rear of the vehicle.



## Lower Anchor Belt Installation with Base

**⚠ WARNINGS:** Do not use the lower anchor belt along with the vehicle lap or lap/shoulder belt.

Check lower anchor belt before each use. Use only if the belt can be tightened properly and securely.

Do not fasten multiple lower anchor hooks on the same lower anchor bar in the vehicle.

Failure to follow these warnings can result in serious injury or death.

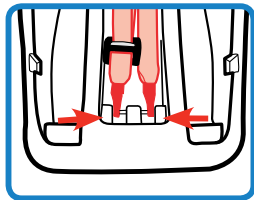

1. Remove Lower Anchor Belt from Storage Location

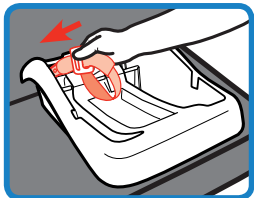

2. Route Lower Anchor Belt Through Base Belt Path

Lower anchor belt adjuster can be on either side.

Do not twist belt.

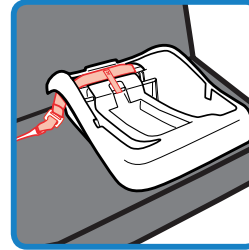
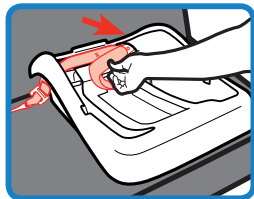

3. Place Base in Vehicle Rear Facing

Center the base between the vehicle's lower anchors in the chosen seating position.

Review your vehicle owner's manual for lower anchor locations and lower anchor belt use.



4. Attach Lower Anchor Hooks to Vehicle's Lower Anchors



5. Tighten Belt

Place hand in base. Firmly push base down and back towards the vehicle seat back while pulling free end of belt to tighten.

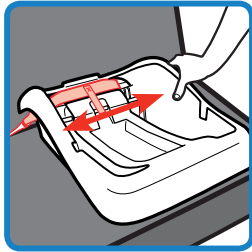

### 6. Check Belt Tightness

Hold base at the belt path with your weakest hand.  
Push and pull from side to side.  
It should not move more than 1 in. (2.5 cm).

If it moves more than 1 in. (2.5 cm), you can try:

- A. Pulling the belt tighter.
- B. Reinstalling the base.
- C. Changing to a different seating location.
- D. Switching to vehicle belt installation.

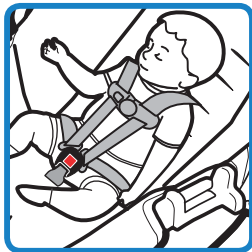

### 7. Secure Child in Child Restraint

See pages 11-15.

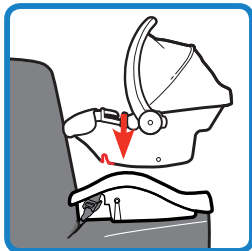

### 8. Attach Child Restraint to Base

To attach to base, see page 16.  
Pull up on front two corners of child restraint by infant's feet to make sure it is locked to the base.  
**Carry handle **MUST** be upright AND locked when installed in the vehicle.**

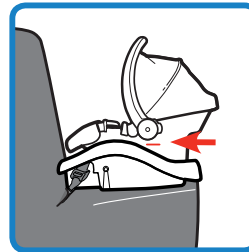

### 9. Check Level Line

Repeat steps 3-8 if level line is not parallel with the ground.

Adjust the base if needed. See **page 17 on how to use the base adjustment.**

**NOTE:** You may need to place a large rolled towel(s) or foam pool noodle(s) under front of base to help make level line parallel with the ground.

Check often to be sure padding is still in place and the belt is tight.

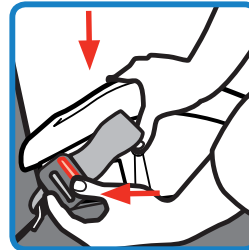
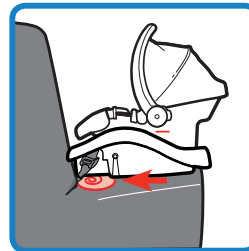

### To Release Lower Anchor Belt

Remove shell from base.

Remove tension from the lower anchor belt by pushing down on side of base with the lower anchor belt adjuster. Then press the adjuster button to loosen belt.

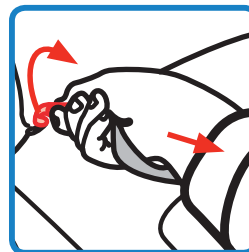

Unhook from anchor by squeezing spring lever on hook, pushing hook back into the seat bight, and twisting. Then pull it out of the vehicle seat.

**Store lower anchor belt when not in use. See page 32.**





## Vehicle Belt Installation with Base

**⚠ WARNINGS:** Do not use the lower anchor belt along with the vehicle lap or lap/shoulder belt. Secure lower anchor belts to storage attachments in base when using the vehicle belts.

Check vehicle belt before each use. Use only if the belt can be tightened properly and locked securely in place.

Failure to follow these warnings can result in serious injury or death.

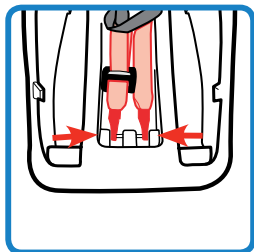

1. Store Lower Anchor Belt

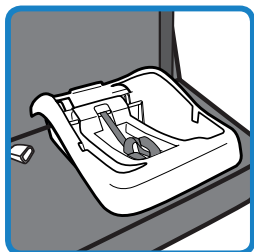

2. Place Base in Vehicle Rear Facing  
Center the base in the chosen seating position.



3. Check if Your Vehicle Belts Will Work With This Child Restraint

This is very important because **not all vehicle belts will work with child restraints.**

Review pages 34-36 and your vehicle owner's manual to determine what kind of vehicle belt you have and how to lock a child restraint in place.



4. Route Vehicle Lap or Lap/Shoulder Belt Through Base Belt Path



5. Buckle Vehicle Belt



### 6. Tighten Belt

Place hand in base. Firmly push base down and back towards the vehicle seat back while pulling free end of belt to tighten.

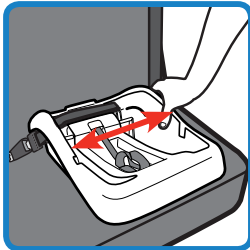

### 7. Check Belt Tightness

Hold base at the belt path with your weakest hand.  
Push and pull from side to side.  
It should not move more than 1 in. (2.5 cm).

**If it moves more than 1 in. (2.5 cm), you can try:**

- A. Pulling the belt tighter.
- B. Reinstalling the base.
- C. Changing to a different seating location.
- D. Switching to the lower anchor belt installation if lower anchors are available in your vehicle.

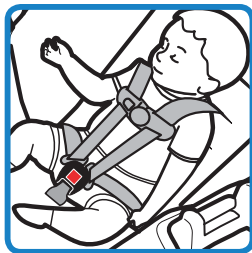

### 8. Secure Child in Child Restraint

See pages 11-15.

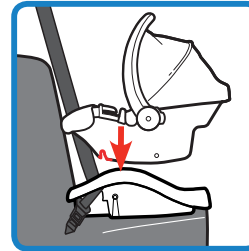

### 9. Attach Child Restraint to Base

To attach to base, see page 16.  
Pull up on front two corners of child restraint by infant's feet to make sure it is locked to the base.

**Carry handle **MUST** be upright **AND** locked when installed in the vehicle.**

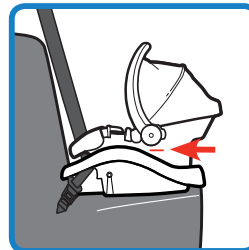

### 10. Check Level Line

Repeat steps 2-8 if level line is not parallel with the ground.

Adjust the base if needed. **See page 17 on how to use the base adjustment.**

**NOTE:** You may need to place a large rolled towel(s) or foam pool noodle(s) under front of base to help make the level line parallel with the ground.

Check often to be sure padding is still in place and the belt is tight.

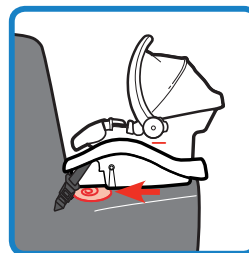



## Rear Facing without Base



4-22 lb (1.8-10 kg)  
29 in. (74 cm) or less

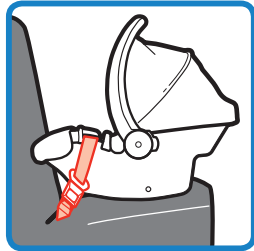

 Lap Belt

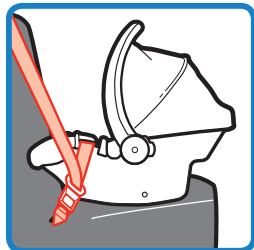

 Lap/Shoulder Belt



**⚠ WARNINGS:** Never place a child rear facing in a seating position with an active frontal airbag. This can result in serious injury or death.

This child restraint must always face the rear of the vehicle.

## Vehicle Belt Installation without Base

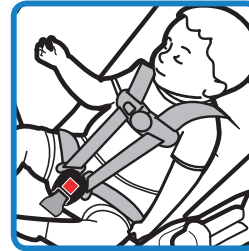

### 1. Secure Child in Child Restraint

See pages 11-15.

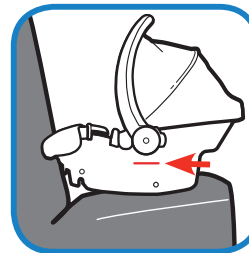

### 2. Place Child Restraint in Vehicle Rear Facing

Center the child restraint in the chosen seating position.

Check the level line to see if it is parallel with the ground.

Adjust if needed.

Carry handle **MUST** be upright AND locked when installed in the vehicle.



### 3. Check if Your Vehicle Belts Will Work With This Child Restraint

This is very important because **not all vehicle belts will work with child restraints.**

Review pages 34-36 and your vehicle owner's manual to determine what kind of vehicle belt you have and how to lock a child restraint in place.

*continued on next page*

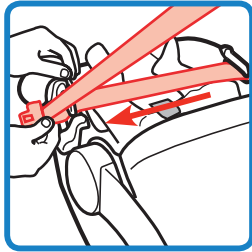

4. Route Vehicle Lap or Lap/Shoulder Belt Through Shell Belt Path As Shown



5. Buckle Vehicle Belt



6. Tighten Vehicle Belt  
Lay your forearm across child restraint at the belt path while pulling up on belt to tighten.

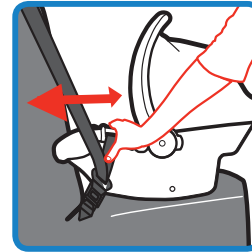

7. Check Belt Tightness

Hold child restraint at the belt path with your weakest hand. Push and pull from side to side. It should not move more than 1 in. (2.5 cm).

If it moves more than 1 in. (2.5 cm), you can try:

- A. Pulling the belt tighter.
- B. Reinstalling the child restraint.
- C. Changing to a different seating location.

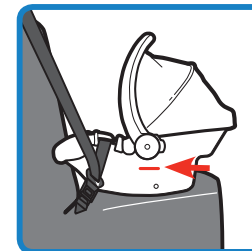

8. Recheck Level Line

Repeat steps 2-6 if level line is not parallel with the ground.

**NOTE:** You may need to place a large rolled towel(s) or foam pool noodle(s) under front of child restraint to help make the level line parallel with the ground.

Check often to be sure padding is still in place and the belt is tight.





## Using a Locking Clip

You will rarely need to use a locking clip except in some older vehicles. Built-in child restraint locking systems have been required in vehicles since 1996, and many vehicles had these features even earlier. Review pages 34-36 and your vehicle owner's manual to determine if your vehicle belts require a locking clip.

If you need a locking clip immediately, they are likely available at an auto dealership, an auto store, or where you purchased this child restraint. You can also call us at 1-800-544-1108 for one.

A locking clip will not fix all types of seat belt problems. You **MUST** have a lap and shoulder belt to use a locking clip.

**For Rear Facing installation with Base**, follow pages 43-44 Warnings and Steps 1-5 before starting locking clip installation.

**For Rear Facing installation without Base**, follow pages 48-49 Warnings and Steps 1-5 before starting locking clip installation.



### 1. Determine Locking Clip Position

Grasp both vehicle belts together just behind the latch plate to mark the position for locking clip.

Unbuckle the belt.

**NOTE:** If the latch plate ends up just at the belt path opening so you

cannot grasp the vehicle belt at the latch plate, grasp the vehicle belts on the opposite side of the child restraint, as close to the latch plate as possible.

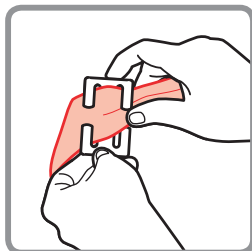

### 2. Attach Locking Clip

Thread both portions of the vehicle belt onto the locking clip, as close to the latch plate as possible.

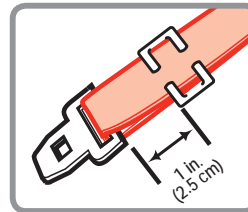

### 3. Position Locking Clip

It should be about 1 in. (2.5 cm) from vehicle belt's latch plate.

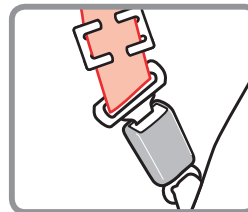

### 4. Rebuckle Vehicle Belt

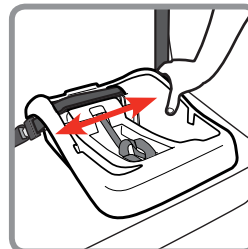

### 5. Check Belt Tightness

Hold base or child restraint at the belt path with your weakest hand.

Push and pull from side to side.

It should not move more than 1 in. (2.5 cm).

**If it moves more than 1 in. (2.5 cm), you can try:**

- A. Reinstalling the base or child restraint.
- B. Changing to a different seating location.

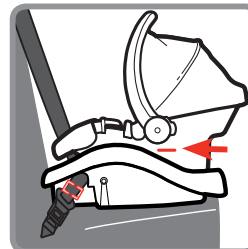

**Recheck the level line.**

**Remove the locking clip when the seat belt is not being used with a child restraint.**

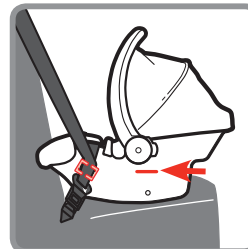

## Dorel Juvenile Group Information

Thank you for choosing this child restraint. The DJG family is committed to creating child restraints with the most comfort and convenience available today.

Remember, parents are a child's first teachers and examples. If you always buckle your seat belt, your child will think it is the natural thing to do. Make it a firm rule that the vehicle does not go until everyone is buckled up. Make no exceptions.

No one can predict if use of a child restraint will prevent injury or death in a particular crash. However, when combined with careful driving, proper use of a child restraint can lower a child's risk of injury or death in most crashes.

Your child's safety is worth the time it will take to read and follow these instructions. After reading, if you still have questions or have any concerns with this child restraint, please contact our Consumer Care Department at:

**Website:** [www.coscokids.com](http://www.coscokids.com)

**Telephone:** 1-800-544-1108

M-TH from 8 A.M. to 6 P.M. EST  
FRI from 8 A.M. to 4:30 P.M. EST

**Mailing Address:**

Dorel Juvenile Group, Inc.  
Consumer Care Department  
P.O. Box 2609  
Columbus, IN 47202-2609

## Registration and Safety Notices

Please complete the postage-paid registration card that came with your child restraint, and send it to us. Child restraints could be recalled for safety reasons. You must register this restraint to be reached in a recall. Send your name, address, email address if available, the restraint's model number, and manufacturing date to:

**Dorel Juvenile Group, Inc.**  
**Consumer Care Department**

P.O. Box 2609  
Columbus, IN 47202-2609

or call 1-800-544-1108 or register online at [www.djgusa.com/registration/carseat/us](http://www.djgusa.com/registration/carseat/us).

For recall information, call the U.S. Government's Vehicle Safety Hotline at 1-888-327-4236 (TTY: 1-800-424-9153), or go to <http://www.NHTSA.gov>.

**Consumer:** Just fill in your name, address and email. Please print (use dark ink).

Your Name \_\_\_\_\_

Your Street Address \_\_\_\_\_

City \_\_\_\_\_ State \_\_\_\_\_

Model Number \_\_\_\_\_ Line Code \_\_\_\_\_ Manufacture Date \_\_\_\_\_

Model Number: AB123CDE      Line Code: S1 CARSEAT      Manufacture Date: 01/22/2015

L#11 B265035

Example of model number, manufacture date, and line code.



If you don't have the card or if your address changes, you will find the model number, manufacture date, and line code on the label located on side of shell.

## Troubleshooting

### 1. Locate a Child Safety Seat Inspection Station for hands on training on how to use your child restraint:

Visit your local Child Passenger Inspection Station or go to <http://www.safercar.gov/cpsApp/cps/index.htm> to find your closest station.

### 2. If the child restraint buckle or harness release lever sticks or you cannot get the straps tight enough around child:

DO NOT LUBRICATE. Check around lever and retractor for dropped food, sticky spilled drinks, dirt, leaves, etc. Clean with warm water and/or remove object with tweezers. If you cannot get the harness to adjust and remain tight with the buckle securely locked, do not use the child restraint.

### 3. If your harness twists:

Straighten the harness each time you put your child in the child restraint to help prevent twisting. Lock the buckle and tighten harness so it will be ready for next use.

## Replacement Parts Order Form

Complete the form. Your model number and manufacturer date code **MUST** be included on the form to ensure proper replacement parts. The codes can be found on a label on side of child restraint. Payment in U.S. dollars must accompany your order. Choose parts needed from the list on the next page. Return the form with payment to:

**Dorel Juvenile Group, Inc.**  
**Consumer Care Department**  
P.O. Box 2609  
Columbus, IN 47202-2609

Please make money orders payable to Dorel Juvenile Group, Inc. Fill in the area on the next page to charge credit card. (Visa or MasterCard **only**). We do not accept cash, personal checks, or other credit cards. All outside of U.S. and Canada **MUST** use credit card.

**Ship To:** (Please Print)

**Name:** \_\_\_\_\_

**Address:** \_\_\_\_\_

**City:** \_\_\_\_\_

**State/Province:** \_\_\_\_\_ **Zip:** \_\_\_\_\_

**Telephone:** \_\_\_\_\_

**Email Address:** \_\_\_\_\_

We **MUST** have this information:

**Model Number (8 to 9 characters):** \_\_\_\_\_

**Manufacture Date (mm/dd/yyyy):** \_\_\_\_\_

## Replacement Parts List

**NOTE:** If requested color is not available, similar color will be substituted. Prices are subject to change.

Part	Cost	Qty	Total Cost
Buckle Assembly.....	\$7.99	___	\$ _____
Seat Pad Set.....	\$19.99	___	\$ _____
Chest Clip.....	\$1.50	___	\$ _____
Lower Anchor Belt .....	\$17.99	___	\$ _____
Instructions.....	\$0.00	___	\$ _____
Locking Clip.....	\$2.50	___	\$ _____
<b>Merchandise Total:</b> .....			\$ _____
<b>Shipping and handling:</b> .....			\$ _____
Up to \$25.00 .....	\$5.95	\$100.01 to \$150.00 .....	\$10.95
\$25.01 to \$50.00 .....	\$6.95	\$150.01 to \$200.00 .....	\$11.95
\$50.01 to \$75.00 .....	\$8.95	\$200.01 and up.....	\$13.95
\$75.01 to \$100.00 .....	\$9.95	Outside Continental USA.....	\$10.00

**Sales Tax** ..... \$ \_\_\_\_\_

(Arizona, California, Georgia, Indiana, Missouri, South Carolina, and Texas residents add applicable sales tax.)

**Grand Total**..... \$ \_\_\_\_\_

No shipping and handling on instructions for quantities under 6. Add \$.50 for each instruction over 6, then add applicable shipping and handling.

### Fill Out For Credit Card

Visa  MasterCard

**Card Exp. Date:**

**Cardholder's Name:**

**Card Number:**

**Signature:**

## Warranty

Dorel Juvenile Group, Inc. (DJG) warrants this product to the original retail purchaser as follows:

This product is warranted against defective materials or workmanship for one year from the date of original purchase. **An original receipt is required to validate your warranty.** DJG will, at its option, provide replacement parts or replace this product. DJG reserves the right to substitute if the part or model has been discontinued.

To make a claim under this warranty you may write to DJG, Consumer Care Department, P. O. Box 2609, Columbus, IN 47202-2609; or call 1-800-544-1108 from 8:00 a.m. to 6:00 p.m. EST Monday through Thursday and from 8:00 a.m. to 4:30 p.m. on Friday.

**Proof of purchase is required and shipping charges are the responsibility of the consumer.**

**Warranty Limitations:** This warranty does not include damages which arise from misuse or abuse of this product.

**Limitation of Damages:** The warranty and remedies as set forth are exclusive and in lieu of all others, oral or written, expressed or implied. In no event will DJG or the dealer selling this product be liable to you for any damages, including incidental or consequential damages, arising out of the use or inability to use this product.

**Limitation of warranties and other warranty terms and state law rights:**

Any implied warranties, including implied warranties of the merchantability and fitness for a particular purpose, shall be limited to the duration and terms of the express written warranty. Some states do not allow limitations as to how long an implied warranty lasts or the exclusion or limitation of incidental or consequential damages, so the above limitations may not apply to you.

This warranty gives you specific legal rights, and you may have other rights, which vary from state to state. Neither DJG nor the dealer selling this product authorized any person to create for it any other warranty, obligation, or liability in connection with this product.

CUT ON DOTTED LINE